

GAS OPERATED PREHEAT CIRCULATING SYSTEM WITH DIGITAL TEMPERATURE CONTROL

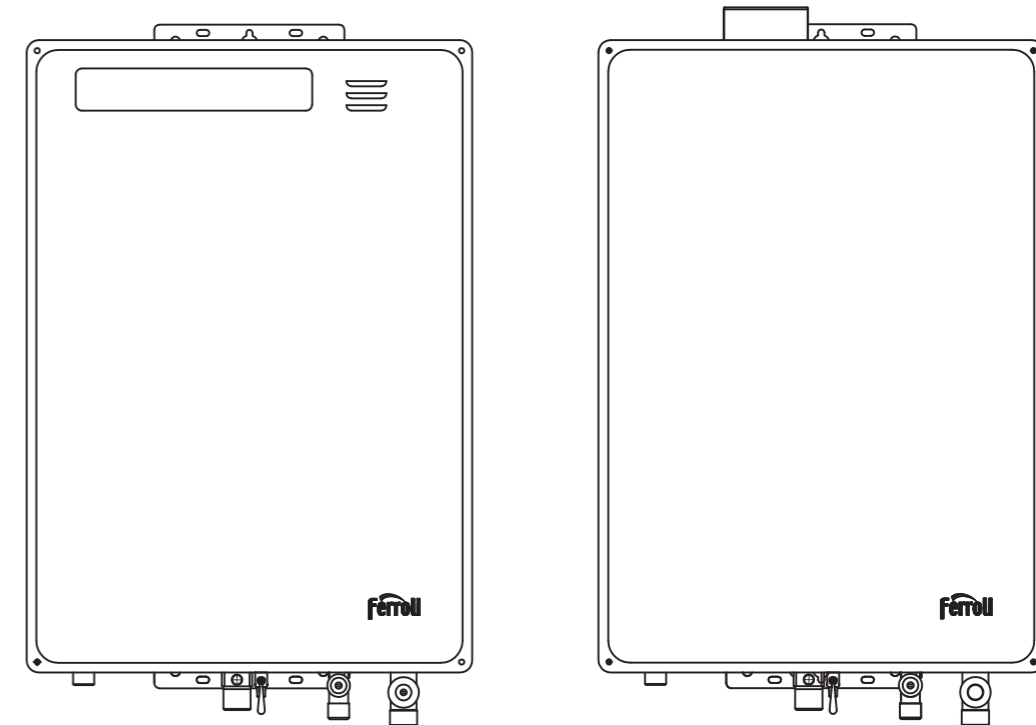

PREHEAT MODEL: GS 12 OE BIP TG (I)
GS 20 OE BIP TG (I)
GS 12 IE BIP TG (I)
GS 20 IE BIP TG (I)





Dear users,

Thank you for selecting Ferroli domestic gas instantaneous water heater for your water heating needs in your home.



We are confident that you will be satisfied with the performance of this water heater as it is developed with the application of our latest technology in water heating.



To enjoy the full benefit of this product, please read this user manual. You are also urged to retain this user manual for easy reference in future.



Contents



| | |
|---|----|
| I. Main diagram of gas water heater | 1 |
| II. Remote Controller | 2 |
| III. Features and Benefits. | 4 |
| IV. Safety Features | 5 |
| V. Preparation before using the heater. | 6 |
| VI. Operating the water heater | 7 |
| VII. Dos and DON'Ts | 9 |
| VIII. Troubleshooting | 11 |
| IX. Specifications | 12 |



I. Main diagram of preheat circulating system

1.1 Outdoor Model

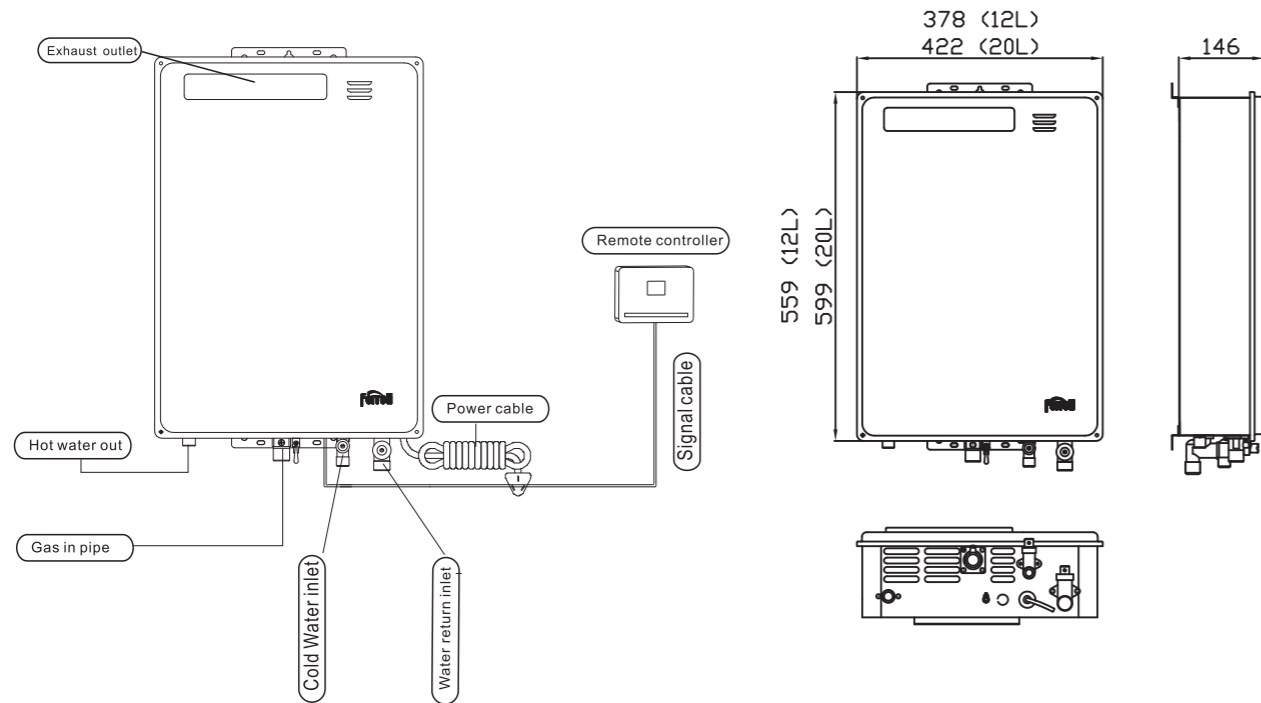

1.2 Indoor Model

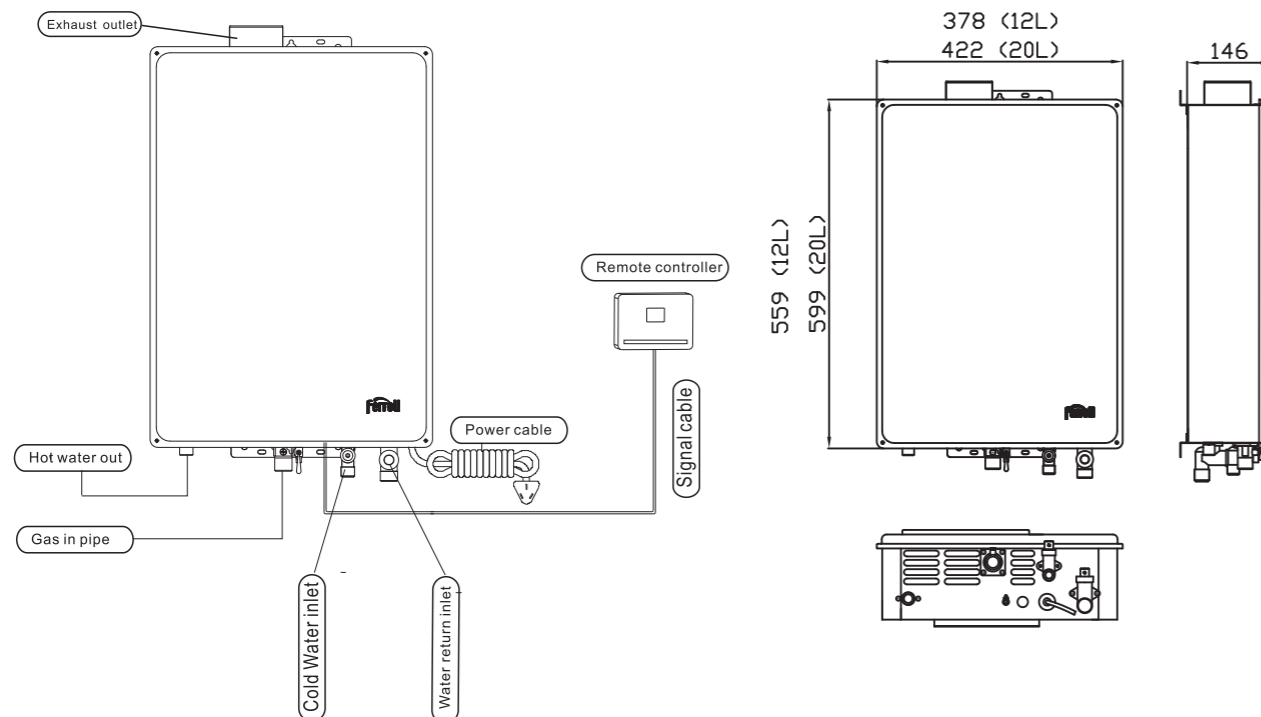

II. Remote Controller

Remote controller size: 140mm (L) x 115mm (W)

Set key

- In standby state, press SET key for 3s to set the time for backlight protection. The default value is 30s and can be regulated by UP and DOWN keys to set the time for backlight screen protection. The setting range is 0-999. The system will confirm the current value and exit setting after no operation for 5s and return to standby state.
- Setting of actual-time clock.

Timer switch

- Switch to turn on and off timer function

Mode key

- Address assignment for remote controller
- Bath mode

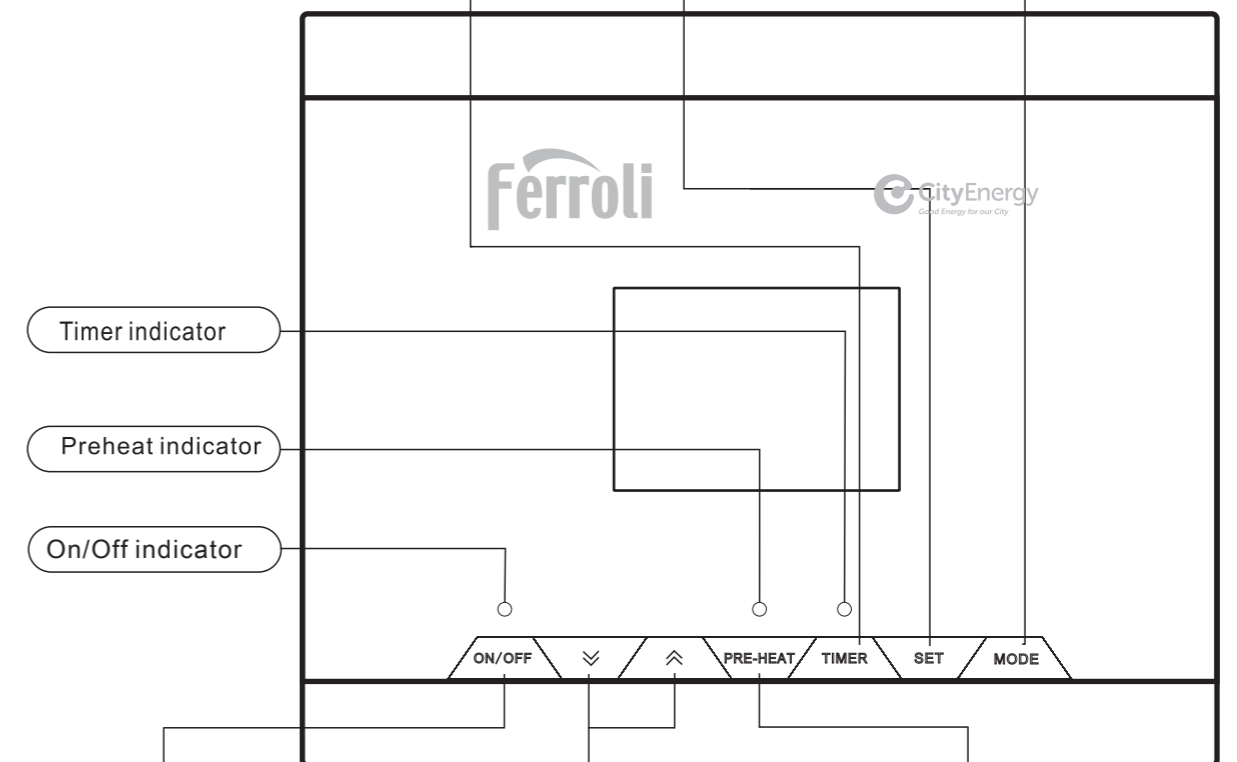

On/Off switch

- Press to turn on and off the water heater

Temperature setting switch

- The hot water temperature can be preset from a range between 35°C - 55°C .

Preheat button

- By activating the preheat switch, the circulating system will generate water at preset temperature. The function will turn off automatically after the hot water is circulated in the water pipe.

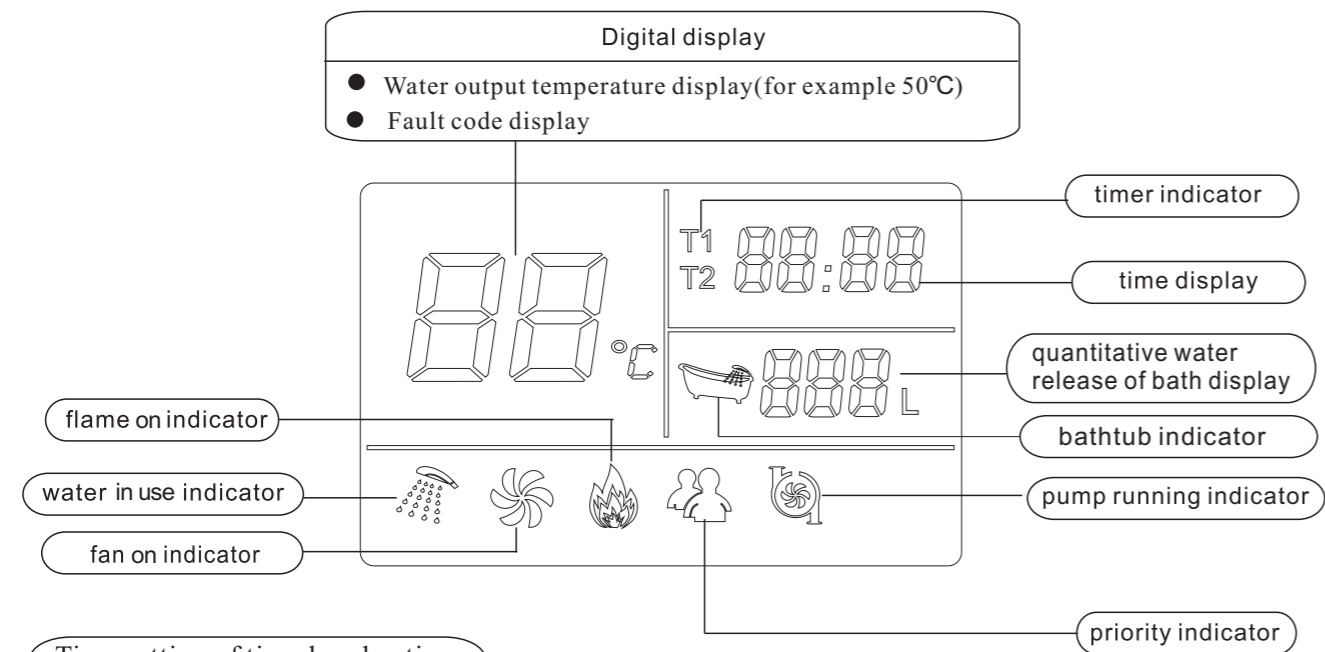

Time setting of timed preheating

- In standby state, press Timer key for 3s to enter the setting of timing interval T1 and T2. After entering this setting, press Timer key to choose the corresponding hour and minute, press UP/DOWN key to change the value of hour and minute. The setting range of hours is "0-23" and the setting range of minutes is "0-59". Keep pressing UP/DOWN key can realize the circulating changes of numbers. The system will save the current value after no operation for 5s and return to show the actual time.
- In startup state, press Timer key once to start the timed heating mode. The indicator light for timing will be on. T1 and T2 will be shown beside actual-time clock. The function can be canceled by pressing the Timer key again.

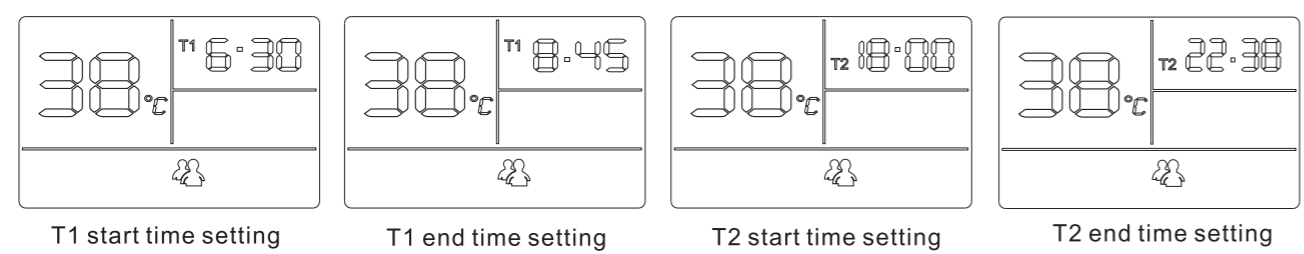

Setting the Time

In startup state, keep pressing SET key for 3s for setting of actual-time clock. Hour value in the 4-digit numerical code flashes and the system enters in to hour setting. At the moment, press UP/DOWN key to add or decrease 1 from hour value which can be set in a circulating way within "0-23"; then press SET key again and the minute value will flash. Press UP/DOWN key to add or decrease 1 from minute value which can be set in a circulating way within "0-59". Keep pressing UP/DOWN key can realize the continuous change of values and press UP/DOWN key again to save data and exit. The system will confirm the current time and exit setting after no operation for 5s and the set time will be shown. Note: The default actual-time clock is at 12:00 in the initial power up.

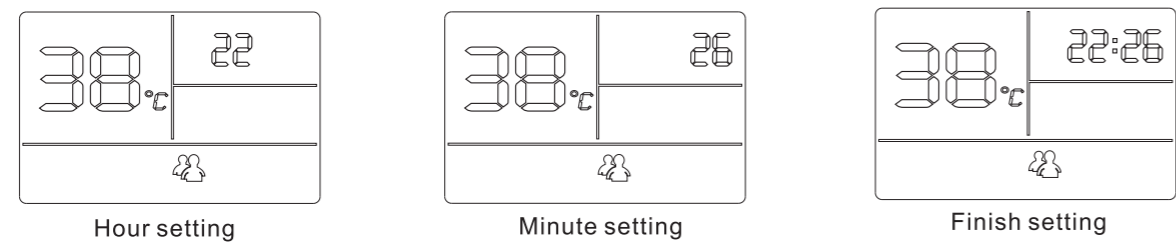

III. Features and Benefits

◆ Compact and Matching Design:

Being compact and aesthetically well designed, the heater does not only save space, it also blends well with all kinds of decor.

◆ Easy to Operate:

Incorporated with micro computer which controls the electronic proportional valve, step-less speed changing DC fan and high loading burning device, the appliance will generate hot water automatically when you switch on the power and turn on the tap.

◆ Pre-setting Required Water Temperature:

With the built-in micro computer, the water heater automatically attempts to generate water at the pre-set temperature. In computing the volume of gas and air to heat up the water flowing into the heater, it takes into consideration the water pressure, the temperature of the water flowing into the heater and the pre-set temperature of the water flowing out of the heater. (please refer to "Note" on page 8 on exceptions).

◆ Low water pressure start:

With the sensitive ultra low water pressure start device, the heater can operate even in areas with low water pressure as low as 0.01MPa.

◆ Remote Controller:

Every heater is equipped with one remote controller, which could be installed away from the water heater to facilitate convenient operation and control. At most, additional 2 more remote controllers could be purchased and installed with the water heater.

◆ Output temperature and fault display:

When the main power switch is first turned on, the LED display will indicate 42°C but after 3 seconds, it will show the actual temperature of the water flowing out of the heater. User in the priority mode may then set their preferred temperature for the water outflow. As long as the main power switch is not turned off, the heater will continue to operate and generate water at the selected pre-set temperature during subsequent usage. The display will also flash the fault code accordingly to indicate the nature of the fault of the heater whenever the heater malfunctions.

IV. Safety Features

◆ Protection against voltage fluctuation and power failure:

If there is fluctuation in the voltage or power failure, the built-in safety protection device in the heater can keep the water heater operate normally or safely stop the water heater from operating.

◆ Automatic flame out protection:

With the IC ion sensitive device, the heater can instantly cut off gas supply when the flame extinguishes itself, thus preventing gas leakage.

◆ Dry burning prevention protection:

The gas valve will immediately and automatically turn off in the event the water heater boil dry.

◆ Over heat prevention device:

If the inlet water pressure or flow rate is too low and the water temperature is too high, the overheat prevention device will be triggered to stop the water heater from operating.

◆ Pressure relief protection:

When the water pressure is too high, the safety valve will be triggered to drain out water and relieve the pressure.

V. Installation Requirement

◆ Installation Requirements

1. Installation and maintenance shall be conducted by qualified professional personnel in accordance with the existing regulations and the manufacturer's instructions.
2. Wrong installation or improper maintenance will cause damage to human or animals or damage of property. The manufacturer won't assume any responsibility for the loss caused by wrong installation or use or noncompliance with the manufacturer's instructions.
3. The product can only be repaired or replaced by qualified professional personnel and with original spare parts if repair or replacement of the product is needed, otherwise, the safety of the product may be threatened.
4. The installation area where the water heater is installed must avoid influence on other people by exhaust gas or noise.
5. The voltage shall be 230V with reliable grounding. Leakage circuit breaker shall be installed according to safety regulations of power supply.
6. The installation location for water heater can not store flammable, explosive and corrosive materials.
7. The upside of installation places of water heater can not be equipped with open wire, electrical appliance, gas pipe. The lower side shall not be equipped with gas oven and gas furnace, etc.

◆ Installation location

Sufficient operation space must be retained for normal maintenance work. Refer to below picture.

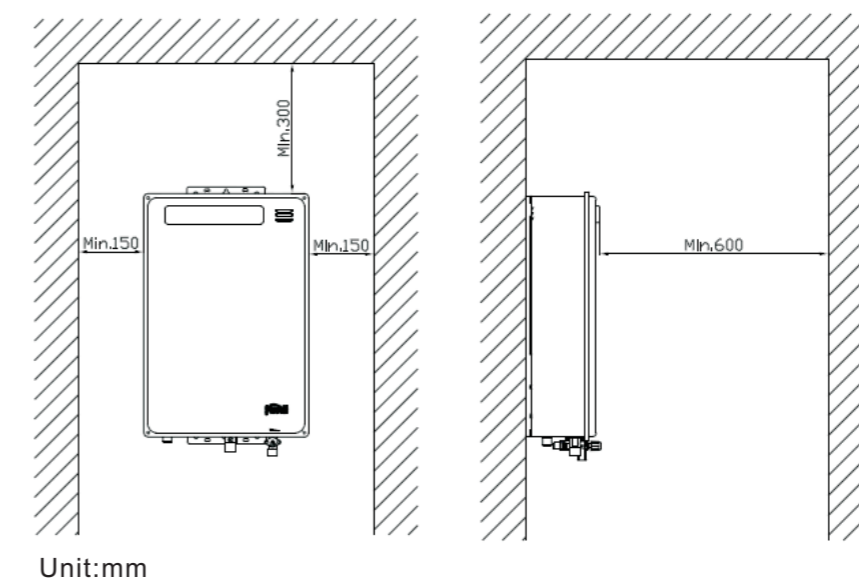

◆ Outdoor model installation

For outdoor model, in the range around the exhaust hole (600mm to the front, 300mm to the top, 150mm to the bottom and 150mm to both sides), there must not be any window which is open to indoor. In order to avoid burnt gas is blown into indoor directly or blown back to indoor by wind. Refer to the shadow area in below picture.

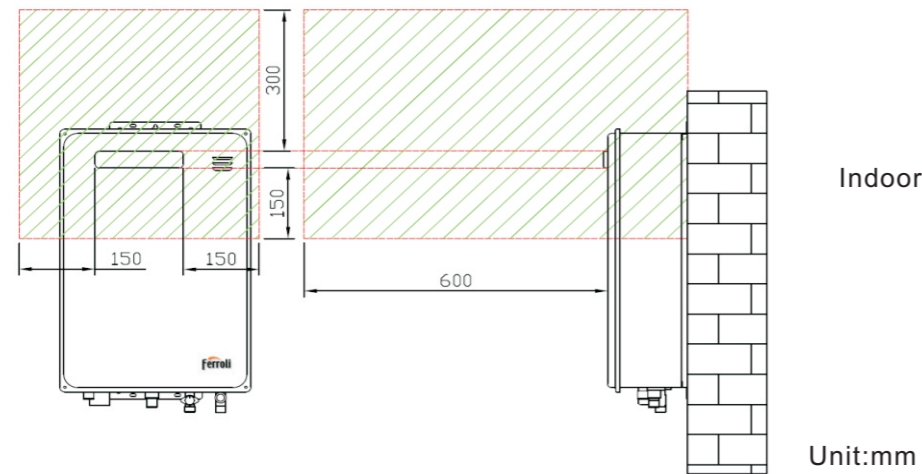

◆ Indoor model installation

1. Backside installation for the exhaust pipe, refer to below picture:

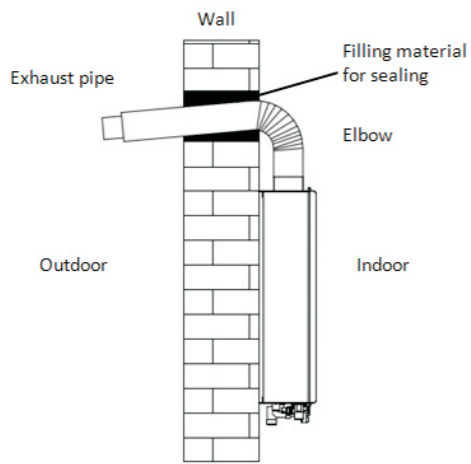

2. Side installation for the exhaust pipe, refer to below picture:

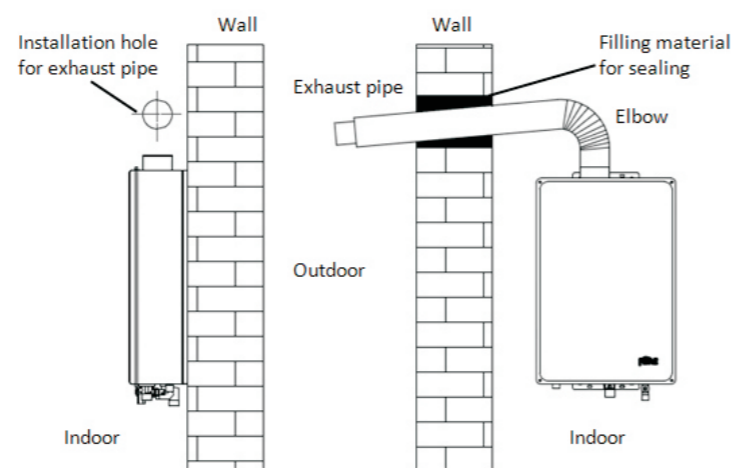

3. Use non-combustible filling material to seal the space between wall and exhaust pipe. Guarantee good sealing and not loose in future.

4. Maximum length of exhaust pipe is 5 meters.
- ◆ One elbow is equal to one meter.
 - ◆ With one elbow, the straight flue part should be Max. 4 meters.
 - ◆ With two elbows, the straight flue part should be Max. 3 meters.

◆ Pipe Connection

1. Before installation, please check and clean all gas pipelines and water pipelines to remove any residue that may influence operation of the water heater.
2. Gas shut-off valve should be installed between the gas pipe system and the water heater. Check whether the connection of all gas pipes is sealed properly.
3. For the necessary of maintenance and repair, water ball valve should be installed between the cold water pipe system and the water heater. Check whether the connection of all water pipes is sealed properly.
4. Before connecting the cold water pipe and water heater, please flush away the residue inside the water pipe. After connecting the water inlet, water outlet and water heater, must check the water heater by turning on water supply.

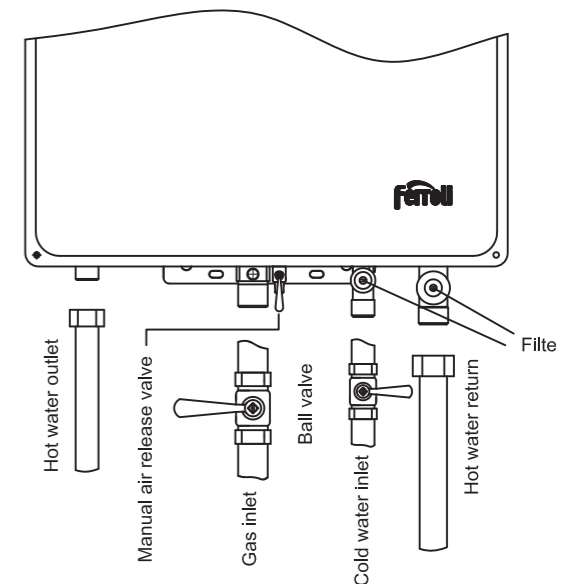

Notice: Before first time use, must release all the air in the water pipe and water heater by turning on and turning off the cold water ball valve several times.

VI. Preparation before using the heater

Please follow the instructions shown below when using the heater for the first time.

1 Turn on the water inlet valve at its maximum

2 Turn on the hot water tap, then turn off when water flows out

Double lever water mixing valve Single lever water mixing valve

3 Insert the power plug into the power socket and switch it on

ON OFF

4 Turn on the gas valve to its maximum

VII. Operating the water heater

6.1 Turning on the water heater

- After the system is power up, the buzzer will buzz once, the full LCD screen will be on, and then off after "00" is shown. The indicator light of On/Off key will be always on. The panel will show "OF" and actual-time clock. At the moment, the system is in OFF mode. To turn on the water heater, press On/Off key, if the system doesn't detect any fault signal, LCD will show the set temperature, actual-time clock and priority icons. At the moment, the system is in starting mode.

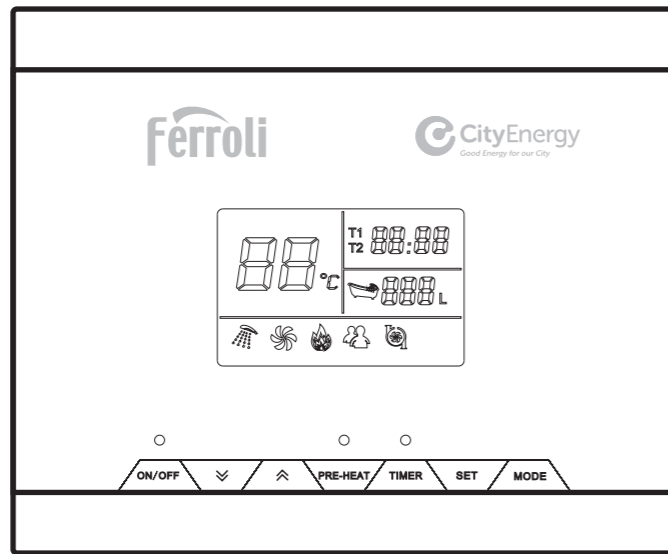

- When the hot water tap is turned on, the burner will automatically ignite, resulting in hot water being generated. When turning on the water heater for the first time, it may be necessary to turn on and off the hot water tap a few times to ignite the heater owing to air in the gas pipe. If hot water tap is not turned on completely, the water heater may either not ignite or there will be a flameout.

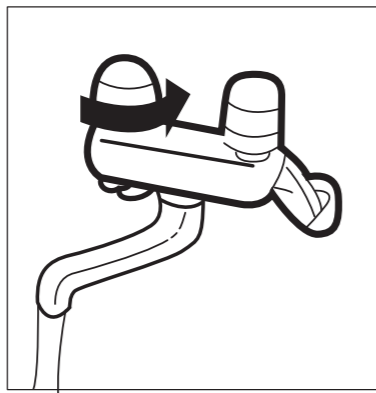

6.2 Adjusting water temperature

In the instance where there are more than 1 bathroom remote controller, to be able to adjust water temperature of a particular bathroom, the user must first confirm that the priority indicator light on the remote controller for that bathroom is on.

| | | |
|--|------------------------------|--|
| Adjust temperature (the one you are using) | If priority indicator is on | <ul style="list-style-type: none"> Hot water temperature can be adjusted |
| | If priority indicator is off | <ul style="list-style-type: none"> The remote controller first switched on is given the priority to set the temperature of the water flowing out of the water heater; as long as the water heater is in operation, the temperature switches on the other remote controllers could not be activated until the remote controller which was first switched on is switched off. In case where the water heater is not in operation, the second remote controller could set the water temperature but the user will first have to activate the priority switch on the second remote controller. Once the second remote controller priority switch is activated, the first user who operates the first remote controller will lose the priority to set the water temperature. |

Note:

While the water heater attempts to generate water at the preset temperature, the water temperature flowing out of the tap may vary from the preset temperature as the temperature is affected by external factors such as the length of the pipe between the water heater and the tap and the temperature of the water flowing into the water heater.

6.3 Bathtub filling

- Press MODE button once to active bathtub filling function, with the number "bathtub icon" flashing, user can set desired quantitative water filling by pressing UP or DOWN button. Indicator flashes to display set value and save set value automatically if no button operation for continuous 5 seconds.
- Press MODE button once again to stop bathtub filling function.
- When water filling is finished, the "bathtub icon" will be flashing and system will be buzzing.
- When water heater is in normal working status, if power is off suddenly, bathtub mode will not be activated automatically after power up again.

VIII. DOs and DON'Ts

A. Avoid Scalding

The air exhaust pipe and surrounding parts are hot when the water heater is in operation or immediately after operation. Please do not touch it.

Before every use, test the water temperature on a small part of your hand first. To prevent scalding, do not spray water from the heater onto body or head immediately when using the heater.

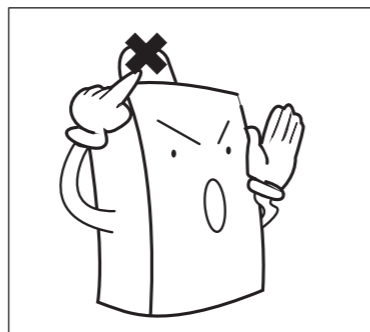

B. Managing Abnormal Operations

Turn off gas valve and water inlet valve immediately if one of the following phenomena occurs:

- a. Gas odor
- b. Abnormal burning sound
- c. Water leakage

Thereafter refer to the “troubleshooting” chart in the manual and take the necessary remedial action. If the problem still persists, notify the appointed authorized distributor after-sales service center for assistance.

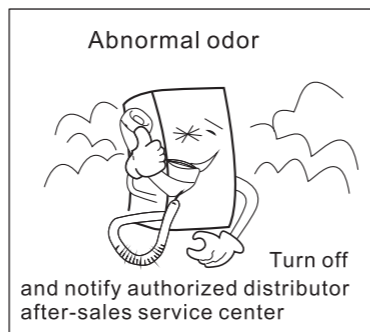

C. Inflammable materials & Ventilation

Ensure that no inflammable materials such as gasoline and benzene are placed near the water heater. Instead, the surrounding of the heater must be well ventilated and it must not be cluttered with materials around it.

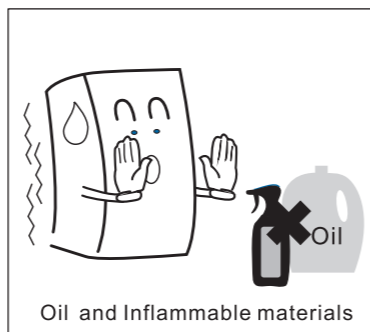

D. Do not open up the water heater

It is risky to dismantle or open up the water heater as it may cause electric shock. Dismantling or opening of the water heater should be left to qualified and authorized technicians.

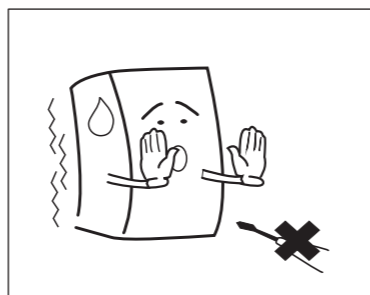

E. Keeping the Water Heater Clean

When cleaning the water heater, do not wipe with fabric or sponge with alcoholic or abrasive or acidic chemicals.

F. Supervising Children Using the Heater

To prevent children from getting scalded, they have to be supervised by adults at all times when using the heater and before bathing them, test the temperature of the water flowing out of the water heater first.

IX. Troubleshooting

8.1 Phenomena below are not faults:

| Phenomena | Reasons and Solutions |
|---|--|
| It takes a while before hot water flows out from the heater after turning on the hot water tap. | When the hot water tap is turned on, the system will first drain out the cold water remaining in the pipe between the heater and the hot water tap. To solve this problem activate the preheat function before using the water heater. |
| No hot water is generated even when the hot water tap is turned on | The flame in the water heater may not be ignited as the hot water tap is not sufficiently turned on to ignite the flame. To rectify this, the hot water tap has to be turned on to the maximum before adjustment. |
| Difficult to ignite when using for the first time | The air in the gas pipe needs to be discharged before the heater could be ignited and this could be resolved by turning on and off the hot water tap repeatedly. |
| Fan remains working for a short moment after turning off the hot water tap | Fan is designed with time delay function for exhausting waste fume from the combustion chamber. |
| Water flows out from the relief valve | The water heater system relieves high water temperature pressure by discharging water through relief valve to normalize the pressure in the heat exchanger. |

8.2 Fault code

LED display screen may flash the fault code to identify the nature of the fault. The possible solutions to the respective faults are shown in the table below:

| Fault code and display | Faults | Solutions |
|------------------------|--|--|
| E0 | Water flowout temperature sensor fault | Turn off the main power and then turn on again, if the fault is not rectified, please call the service center. |
| E1 | Fail to ignite | Ensure the gas valve is turned on. Turn off water tap and then turn on again. If the fault is not rectified, please call the service center. |
| E2 | Flame sensor fault | Please call the service center. |
| E3 | Dry burning or overheating in the heat exchanger | Turn off water tap and then turn on again. If the fault is not rectified, please call the service center. |
| E5 | Fan motor fault | Please call the service center. |
| E6 | Water temperature is over 90°C last for 10s | Turn off water tap and then turn on again. If the fault is not rectified, please call the service center. |
| E7 | Gas valve fault | Please call the service center. |
| E8 | Circulating system fault | Please call the service center. |
| EE | Continuous running for over 30min(safety design) | Turn off water tap and then turn on again, the fault code will disappear |
| A0 | Water return temperature sensor fault | Turn off the main power and then turn on again, if the fault is not rectified, please call the service center. |
| EC | Communication error | Please contact the service center |

X. Specifications

| Preheat circulating system model | GS 12 OE BIP TG GS 12 IE BIP TG | GS 20 OE BIP TG GS 20 IE BIP TG |
|------------------------------------|--|--|
| Type of gas | Town Gas | |
| Rated gas pressure | 1.5kPa | |
| Heat Load | 24kW | 40kW |
| Hot Water Output Capacity | 20L/min(temperaturerise:25K) | 20L/min(temperaturerise:25K) |
| Exhaust Mode or Installation Model | Outdoor / Indoor | |
| Heat Efficiency | > 88% | |
| Ignition Mode | Hydraulic Type Electric Pulse Ignition | |
| Lowest Start Water Pressure | 0.01MPa | |
| Applicable Water Pressure | 0.01MPa~0.5MPa | |
| Control Mode | Hot Water Temperature Control Mode | Electronic Proportional Valve + Electronic Fire Section Control Mode |
| | Delay Ignition Mode | Soft Start Mode |
| Connection Pipe Mode | Water inlet and outlet | G1/2 G1/2 (hot and cold water) G3/4 (water return) |
| | Gas Inlet | G1/2 G3/4 |
| | Exhaust | No(outdoor model) Φ80mm(20L indoor model), Φ60mm for 12L type |
| Electric Features | Voltage, Frequency of Power Supply | AC230V / 50Hz |
| | Rated Power | 60W (water heater) 93W (circulator) |
| | Fan | DC Motor |
| | Power Cord | 1.5m (with 13A approved plug) |
| Dimension | 559x378x146mm | 599x442x146mm |

Ferroli is continually updating and improving products, therefore specifications are subject to change without prior notice.